

bq35100 Lithium Primary Battery Fuel Gauge and End-Of-Service Monitor

1 Features

- Fuel Gauge for Single- and Multi-Cell Primary (Non-Rechargeable) Batteries
- Supports Lithium Thionyl Chloride (LiSOCl₂) and Lithium Manganese Dioxide (LiMnO₂)
- Provides Four Configurable Algorithm Options:
 - Coulomb Accumulation (ACC)
 - State-Of-Health (SOH)
 - End-Of-Service (EOS)
- Ultra-Low Average Power Consumption Supported Through Gauge-Enable Control
- Accurate Coulomb Counter, Voltage, and Temperature Measurement Options
- I²C™ Host Communication, Providing Battery Parameter and Status Access
- Configurable Host Interrupt
- Data Logging Options
- SHA-1 Authentication

2 Applications

- Smart Metering
- Door Access Control
- Smoke/Gas Detection
- Building Automation
- IoT, Including Sensor Node
- Asset Tracking

3 Description

The bq35100 Battery Fuel Gauge and End-Of-Service Monitor provides highly configurable fuel gauging for non-rechargeable lithium primary batteries—without requiring forced discharge of the battery. Built so that optimization is not necessary, the patented TI gauging algorithms support replaceable batteries and enable accurate results with ultra-low average power consumption through host control via the GAUGE ENABLE (GE) pin.

The fuel gauging functions use voltage, current, and temperature information to provide State-Of-Health (SOH) and End-Of-Service (EOS) data. The bq35100 device is only required to be powered long enough to gather data and to make calculations to support the selected algorithm and the frequency of updates required by the system.

The host can read the gathered data through a 400-kHz I²C bus. An ALERT output is also available to interrupt the host, based on a variety of configurable options.

Device Information⁽¹⁾

PART NUMBER	PACKAGE	BODY SIZE (NOM)
bq35100	TSSOP (14)	5.00 mm × 4.40 mm

(1) For all available packages, see the orderable addendum at the end of the data sheet.

Simplified Schematic

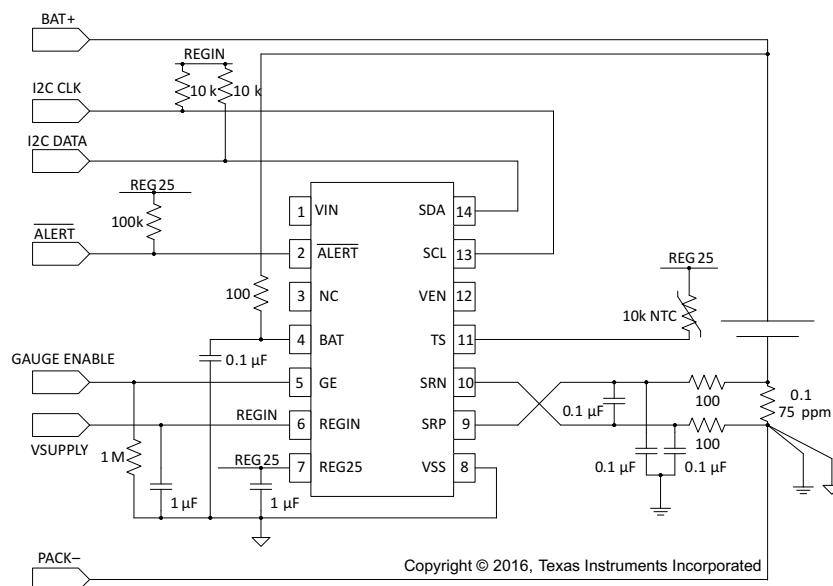

Table of Contents

1 Features	1	6.14 Typical Characteristics	8
2 Applications	1	7 Detailed Description	9
3 Description	1	7.1 Overview	9
4 Revision History	2	7.2 Functional Block Diagram	9
5 Pin Configuration and Functions	3	7.3 Feature Description	9
6 Specifications	4	7.4 Device Functional Modes	14
6.1 Absolute Maximum Ratings	4	8 Application and Implementation	16
6.2 ESD Ratings	4	8.1 Application Information	16
6.3 Recommended Operating Conditions	4	8.2 Typical Applications	16
6.4 Thermal Information	5	9 Power Supply Recommendations	18
6.5 Electrical Characteristics: Digital Input and Outputs	5	10 Layout	18
6.6 Electrical Characteristics: Power-On Reset	5	10.1 Layout Guidelines	18
6.7 Electrical Characteristics: LDO Regulator	5	10.2 Layout Example	19
6.8 Electrical Characteristics: Internal Temperature Sensor	6	10.3 ESD Spark Gap	20
6.9 Electrical Characteristics: Internal Clock Oscillators	6	11 Device and Documentation Support	21
6.10 Electrical Characteristics: Integrating ADC (Coulomb Counter)	6	11.1 Documentation Support	21
6.11 Electrical Characteristics: ADC (Temperature and Voltage Measurements)	6	11.2 Receiving Notification of Documentation Updates	21
6.12 Electrical Characteristics: Data Flash Memory	7	11.3 Community Resources	21
6.13 Electrical Characteristics: I ² C-Compatible Interface Timing Characteristics	7	11.4 Trademarks	21
		11.5 Electrostatic Discharge Caution	21
		11.6 Glossary	21
		12 Mechanical, Packaging, and Orderable Information	21

4 Revision History

Changes from Revision A (July 2016) to Revision B

Page

• Changed <i>Device Information</i>	1
• Changed <i>Specifications</i>	4
• Changed <i>Application Curves</i>	18
• Changed V _{CC} to V _{REG25} in <i>Layout Guidelines</i>	18
• Changed V _{CC} to V _{REG25} in <i>Board Offset Considerations</i>	20

5 Pin Configuration and Functions

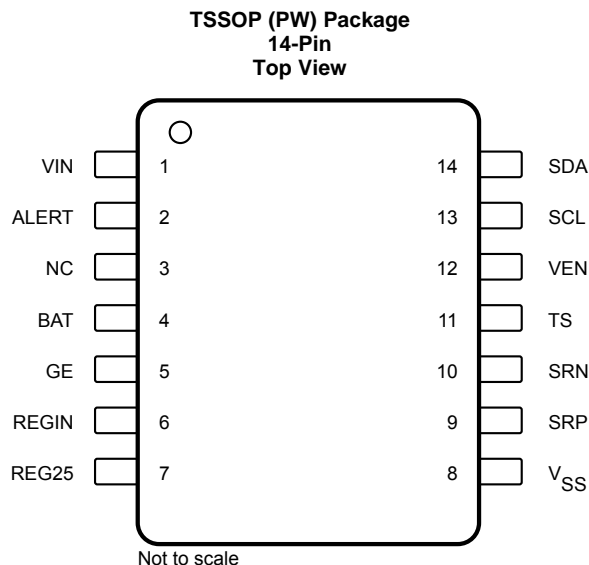

Pin Functions

NUMBER	NAME	I/O	DESCRIPTION
1	VIN	AI ⁽¹⁾	Optional voltage measurement input
2	$\overline{\text{ALERT}}$	O	Active low interrupt open drain output. Requires an external pull-up
3	NC	—	Not used and should be connected to V _{SS} .
4	BAT	P	Voltage measurement input and can be left floating or tied to V _{SS} if not used.
5	GE	I	Gauge enable. Internal LDO is disconnected from REGIN when driven low.
6	REGIN	P	Internal integrated LDO input. Decouple with 0.1- μ F ceramic capacitor to V _{SS} .
7	REG25	P	2.5-V output voltage of the internal integrated LDO. Decouple with 1- μ F ceramic capacitor V _{SS} .
8	V _{SS}	P	Device ground
9	SRP	I	Analog input pin connected to the internal coulomb-counter peripheral for integrating a small voltage between SRP and SRN where SRP is nearest the BAT– connection.
10	SRN	I	Analog input pin connected to the internal coulomb-counter peripheral for integrating a small voltage between SRP and SRN where SRN is nearest the PACK– connection.
11	TS	I	Pack thermistor voltage sense (use 103AT-type thermistor)
12	VEN	O	Optional open drain external voltage divider control output
13	SCL	I	Slave I ² C serial communication clock input. Use with a 10-K pull-up resistor (typical).
14	SDA	I/O	Open drain slave I ² C serial communication data line. Use with a 10-k Ω pull-up resistor (typical).

(1) P = Power Connection, O = Digital Output, AI = Analog Input, I = Digital Input, I/OD = Digital Input/Output

6 Specifications

6.1 Absolute Maximum Ratings

Over-operating free-air temperature range (unless otherwise noted)⁽¹⁾

		MIN	MAX	UNIT
V _{REGIN}	Regulator Input Range	-0.3	5.5	V
V _{REG25}	Supply Voltage Range	-0.3	2.75	V
V _{IOD}	Open-drain I/O pins (SDA, SCL, VEN)	-0.3	5.5	V
	Open-drain I/O pins (ALERT)	-0.3	2.75	V
V _{BAT}	BAT Input Pin	-0.3	5.5	V
V _I	Input voltage range (SRN, SRP, TS)	-0.3	V _{REG25} + 0.3	V
T _A	Operating free-air temperature range	-40	85	°C
T _F	Functional Temperature Range	-40	100	°C
T _{STG}	Storage temperature range	-65	150	°C
	Lead temperature (soldering, 10 s)	-40	100	°C

(1) Stresses beyond those listed under *absolute maximum ratings* may cause permanent damage to the device. These are stress ratings only, and functional operation of the device at these or any other conditions beyond those indicated under *Recommended Operating Conditions* is not implied. Exposure to absolute–maximum–rated conditions for extended periods may affect device reliability.

6.2 ESD Ratings

		VALUE	UNIT
V _(ESD)	Electrostatic discharge	Human Body Model (HBM), per ANSI/ESDA/JEDEC JS-001 ⁽¹⁾ , BAT pin	±1500
		Human Body Model (HBM), per ANSI/ESDA/JEDEC JS-001 ⁽¹⁾ , all other pins	±2000
		Charged-device model (CDM), per JEDEC specification JESD22-C101 ⁽²⁾	±500

(1) JEDEC document JEP155 states that 500-V HBM allows safe manufacturing with a standard ESD control process.

(2) JEDEC document JEP157 states that 250-V CDM allows safe manufacturing with a standard ESD control process.

6.3 Recommended Operating Conditions

T_A = -40°C to 85°C; Typical Values at T_A = 25°C C_{LDO25} = 1.0 μF, and V_{REGIN} = 3.6 V (unless otherwise noted)

			MIN	NOM	MAX	UNIT
V _{REGIN}	Supply Voltage	No operating restrictions	2.7		4.5	V
		No FLASH writes	2.45		2.7	V
C _{REGIN}	External input capacitor for internal LDO between REGIN and V _{SS}	Nominal capacitor values specified. Recommend a 10% ceramic X5R type capacitor located close to the device.		0.1		μF
C _{LDO25}	External output capacitor for internal LDO between V _{REG25}		0.47	1		μF
I _{CC_WAIT}	Gas gauge in WAITING mode	GE = High AND <i>GaugeStart()</i> not received or <i>GaugeStop()</i> Received (GMSEL1,0 = x,x)		15		μA
I _{CC_ACCU}	Gas gauge in ACCUMULATOR mode	GE = High AND <i>GaugeStart()</i> received and <i>GaugeStop()</i> not Received (GMSEL1,0 = 0,0)		130		μA
I _{CC_SOH}	State-Of-Health operating current	GE = High AND <i>GaugeStart()</i> received and <i>GaugeStop()</i> not Received (GMSEL1,0 = 0,1)		40		μA
I _{CC_EOS_Burst}	End-Of-Service operating current—data burst	GE = High AND <i>GaugeStart()</i> received and <i>GaugeStop()</i> not Received (GMSEL1,0 = 1,0)		315		μA
I _{CC_EOS_Gather}	End-Of-Service operating current—data gathering	GE = High AND <i>GaugeStart()</i> AND <i>GaugeStop()</i> Received (GMSEL1,0 = 1,0)		75		μA
VA1	Input voltage range (VIN, TS)		V _{SS} - 0.05		1	V
VA2	Input voltage range (BAT)		V _{SS} - 0.125		5.0	V

Recommended Operating Conditions (continued)

 $T_A = -40^{\circ}\text{C}$ to 85°C ; Typical Values at $T_A = 25^{\circ}\text{C}$ $C_{LDO25} = 1.0\ \mu\text{F}$, and $V_{\text{REGIN}} = 3.6\ \text{V}$ (unless otherwise noted)

		MIN	NOM	MAX	UNIT
VA3	Input voltage range (SRP, SRN)	$V_{\text{SS}} - 0.125$		0.125	V
ILKG	Input leakage current (I/O pins)			0.3	μA
t_{PUCD}	Power-up communication		250		ms

6.4 Thermal Information

THERMAL METRIC ⁽¹⁾		bq35100			UNIT
		TSSOP (PW)			
		14 PINS			
$R_{\theta\text{JA, High K}}$	Junction-to-ambient thermal resistance	103.8			$^{\circ}\text{C}/\text{W}$
$R_{\theta\text{JC(top)}}$	Junction-to-case(top) thermal resistance	31.9			$^{\circ}\text{C}/\text{W}$
$R_{\theta\text{JB}}$	Junction-to-board thermal resistance	46.6			$^{\circ}\text{C}/\text{W}$
Ψ_{JT}	Junction-to-top characterization parameter	2.0			$^{\circ}\text{C}/\text{W}$
Ψ_{JB}	Junction-to-board characterization parameter	45.9			$^{\circ}\text{C}/\text{W}$
$R_{\theta\text{JC(bottom)}}$	Junction-to-case(bottom) thermal resistance	N/A			$^{\circ}\text{C}/\text{W}$

(1) For more information about traditional and new thermal metrics, see the *Semiconductor and IC Package Thermal Metrics* application report, [SPRA953](#).

6.5 Electrical Characteristics: Digital Input and Outputs

PARAMETER		TEST CONDITIONS	MIN	TYP	MAX	UNIT
V_{OL}	Output voltage low (SDA, SCL, VEN)	$I_{\text{OL}} = 3\ \text{mA}$			0.4	V
$V_{\text{OH(PP)}}$	Output high voltage	$I_{\text{OH}} = -1\ \text{mA}$	$V_{\text{REG25}} - 0.5$			V
$V_{\text{OH(OD)}}$	Output high voltage (SDA, SCL, VEN, ALERT)	External pullup resistor connected to V_{REG25}	$V_{\text{REG25}} - 0.5$			V
V_{IL}	Input voltage low (SDA, SCL)		-0.3		0.6	V
V_{IH}	Input voltage high (SDA, SCL)		1.2		5.5	V
$V_{\text{IL(GE)}}$	GE Low-level input voltage	$V_{\text{REGIN}} = 2.8$ to $4.5\ \text{V}$			0.8	V
$V_{\text{IH(GE)}}$	GE High-level input voltage		2.65			
I_{Ikg}	Input leakage current (I/O pins)				0.3	μA

6.6 Electrical Characteristics: Power-On Reset

 $T_A = -40^{\circ}\text{C}$ to 85°C ; Typical Values at $T_A = 25^{\circ}\text{C}$ and $V_{\text{REGIN}} = 3.6\ \text{V}$ (unless otherwise noted)

PARAMETER		TEST CONDITIONS	MIN	TYP	MAX	UNIT
$V_{\text{IT+}}$	Positive-going battery voltage input at REG25		2.05	2.20	2.31	V
V_{HYS}	Power-on reset hysteresis			115		mV

6.7 Electrical Characteristics: LDO Regulator

 $T_A = 25^{\circ}\text{C}$, $C_{\text{LDO25}} = 1.0\ \mu\text{F}$, $V_{\text{REGIN}} = 3.6\ \text{V}$ (unless otherwise noted)⁽¹⁾

PARAMETER		TEST CONDITIONS	MIN	TYP	MAX	UNIT
V_{REG25}	Regulator output voltage	$2.7\ \text{V} \leq V_{\text{REGIN}} \leq 4.5\ \text{V}$, $I_{\text{OUT}} \leq 16\ \text{mA}$ $T_A = -40^{\circ}\text{C}$ to 85°C	2.3	2.5	2.7	V
		$2.45\ \text{V} \leq V_{\text{REGIN}} < 2.7\ \text{V}$, $I_{\text{OUT}} \leq 3\ \text{mA}$ $T_A = -40^{\circ}\text{C}$ to 85°C	2.3			

(1) LDO output current, I_{OUT} , is the sum of internal and external load currents.

Electrical Characteristics: LDO Regulator (continued)

 $T_A = 25^\circ\text{C}$, $C_{LDO25} = 1.0\ \mu\text{F}$, $V_{\text{REGIN}} = 3.6\ \text{V}$ (unless otherwise noted)⁽¹⁾

PARAMETER	TEST CONDITIONS	MIN	TYP	MAX	UNIT
$I_{\text{SHORT}}^{(2)}$ Short circuit current limit	$V_{\text{REG25}} = 0\ \text{V}$ $T_A = -40^\circ\text{C}$ to 85°C			250	mA

(2) Specified by design. Not production tested.

6.8 Electrical Characteristics: Internal Temperature Sensor

 $T_A = -40^\circ\text{C}$ to 85°C , $2.4\ \text{V} < \text{REG25} < 2.6\ \text{V}$; Typical Values at $T_A = 25^\circ\text{C}$ and $\text{REG25} = 2.5\ \text{V}$ (unless otherwise noted)

PARAMETER	TEST CONDITIONS	MIN	TYP	MAX	UNIT
G_{TEMP} Internal temperature sensor voltage gain			-2		mV/°C

6.9 Electrical Characteristics: Internal Clock Oscillators

 $T_A = -40^\circ\text{C}$ to 85°C , $2.4\ \text{V} < \text{REG25} < 2.6\ \text{V}$; Typical Values at $T_A = 25^\circ\text{C}$ and $\text{REG25} = 2.5\ \text{V}$ (unless otherwise noted)

PARAMETER	TEST CONDITIONS	MIN	TYP	MAX	UNIT
$f_{(\text{LOSC})}$ Operating frequency			32.768		kHz
$f_{(\text{OSC})}$ Operating frequency			2.097		MHz
$t_{(\text{SXO})}$ Start-up time ⁽¹⁾			2.5	5	ms

(1) The startup time is defined as the time it takes for the oscillator output frequency to be $\pm 3\%$.

6.10 Electrical Characteristics: Integrating ADC (Coulomb Counter)

 $T_A = -40^\circ\text{C}$ to 85°C , $2.4\ \text{V} < \text{REG25} < 2.6\ \text{V}$; Typical Values at $T_A = 25^\circ\text{C}$ and $\text{REG25} = 2.5\ \text{V}$ (unless otherwise noted)

PARAMETER	TEST CONDITIONS	MIN	TYP	MAX	UNIT
$V_{(\text{SR})}$ Input voltage range, $V_{(\text{SRN})}$ and $V_{(\text{SRP})}$	$V_{(\text{SR})} = V_{(\text{SRN})} - V_{(\text{SRP})}$	-0.125		0.125	V
$t_{\text{SR_CONV}}$	Conversion time		1		s
	Resolution	14		15	bits
$V_{\text{OS}(\text{SR})}$ Input offset			10		μV
INL Integral nonlinearity error			$\pm 0.007\%$		FSR ⁽¹⁾
$Z_{\text{IN}(\text{SR})}$ Effective input resistance ⁽²⁾		2.5			M Ω
$I_{\text{LKG}(\text{SR})}$ Input leakage current ⁽²⁾				0.3	μA

(1) Full-scale reference

(2) Specified by design. Not tested in production.

6.11 Electrical Characteristics: ADC (Temperature and Voltage Measurements)

 $T_A = -40^\circ\text{C}$ to 85°C , $2.4\ \text{V} < \text{REG25} < 2.6\ \text{V}$; Typical Values at $T_A = 25^\circ\text{C}$ and $\text{REG25} = 2.5\ \text{V}$ (unless otherwise noted)

PARAMETER	TEST CONDITIONS	MIN	TYP	MAX	UNIT
$V_{\text{IN}(\text{BAT})}$ BAT Input range		$V_{\text{SS}} - 0.125$		5	V
$V_{\text{IN}(\text{TSAT})}$ TS Input range		$V_{\text{SS}} - 0.125$		V_{REG25}	V
$t_{\text{SR_CONV}}$	Conversion time		125		ms
	Resolution	14		15	bits
$V_{\text{OS}(\text{SR})}$ Input offset			1		μV
Z_{ADC1} Effective input resistance(TS) ⁽¹⁾	With internal pull-down activated	5			k Ω
Z_{ADC2} Effective input resistance(BAT) ⁽¹⁾	When not measuring	8			M Ω
	During measurement		100		k Ω

(1) Specified by design. Not tested in production.

Electrical Characteristics: ADC (Temperature and Voltage Measurements) (continued)

$T_A = -40^{\circ}\text{C}$ to 85°C , $2.4\text{ V} < \text{REG25} < 2.6\text{ V}$; Typical Values at $T_A = 25^{\circ}\text{C}$ and $\text{REG25} = 2.5\text{ V}$ (unless otherwise noted)

PARAMETER	TEST CONDITIONS	MIN	TYP	MAX	UNIT
$I_{\text{LKG(ADC)}}$	Input leakage current ⁽¹⁾			0.3	μA

6.12 Electrical Characteristics: Data Flash Memory

$T_A = -40^{\circ}\text{C}$ to 85°C , $2.4\text{ V} < \text{REG25} < 2.6\text{ V}$; Typical Values at $T_A = 25^{\circ}\text{C}$ and $\text{REG25} = 2.5\text{ V}$ (unless otherwise noted)

PARAMETER	TEST CONDITIONS	MIN	TYP	MAX	UNIT
t_{DR}	Data retention ⁽¹⁾	10			Years
	Flash-programming write cycles ⁽¹⁾	20,000			Cycles
t_{WORDPROG}	Word programming time ⁽¹⁾			2	ms
I_{CCPROG}	Flash-write supply current ⁽¹⁾		5	10	mA

(1) Specified by design. Not tested in production.

6.13 Electrical Characteristics: I²C-Compatible Interface Timing Characteristics

$T_A = -40^{\circ}\text{C}$ to 85°C , $2.45\text{ V} < V_{\text{REGIN}} = V_{\text{BAT}} < 5.5\text{ V}$; Typical Values at $T_A = 25^{\circ}\text{C}$ and $V_{\text{BAT}} = 3.6\text{ V}$ (unless otherwise noted)

		MIN	NOM	MAX	UNIT
t_{R}	SCL/SDA rise time			300	ns
t_{F}	SCL/SDA fall time			300	ns
$t_{\text{W(H)}}$	SCL pulse width (high)	600			ns
$t_{\text{W(L)}}$	SCL pulse width (low)	1.3			μs
$t_{\text{SU(STA)}}$	Setup for repeated start	600			ns
$t_{\text{d(STA)}}$	Start to first falling edge of SCL	600			ns
$t_{\text{SU(DAT)}}$	Data setup time	100			ns
$t_{\text{h(DAT)}}$	Data hold time	0			ns
$t_{\text{SU(STOP)}}$	Setup time for stop	600			ns
t_{BUF}	Bus free time between stop and start	66			μs
f_{SCL}	Clock frequency			400	kHz

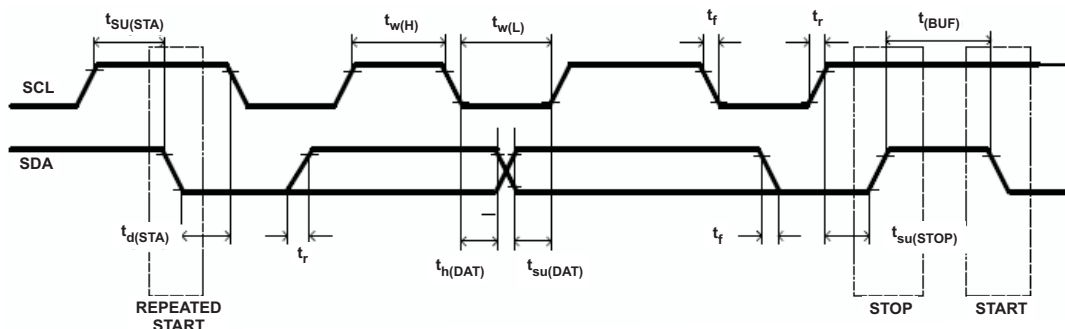
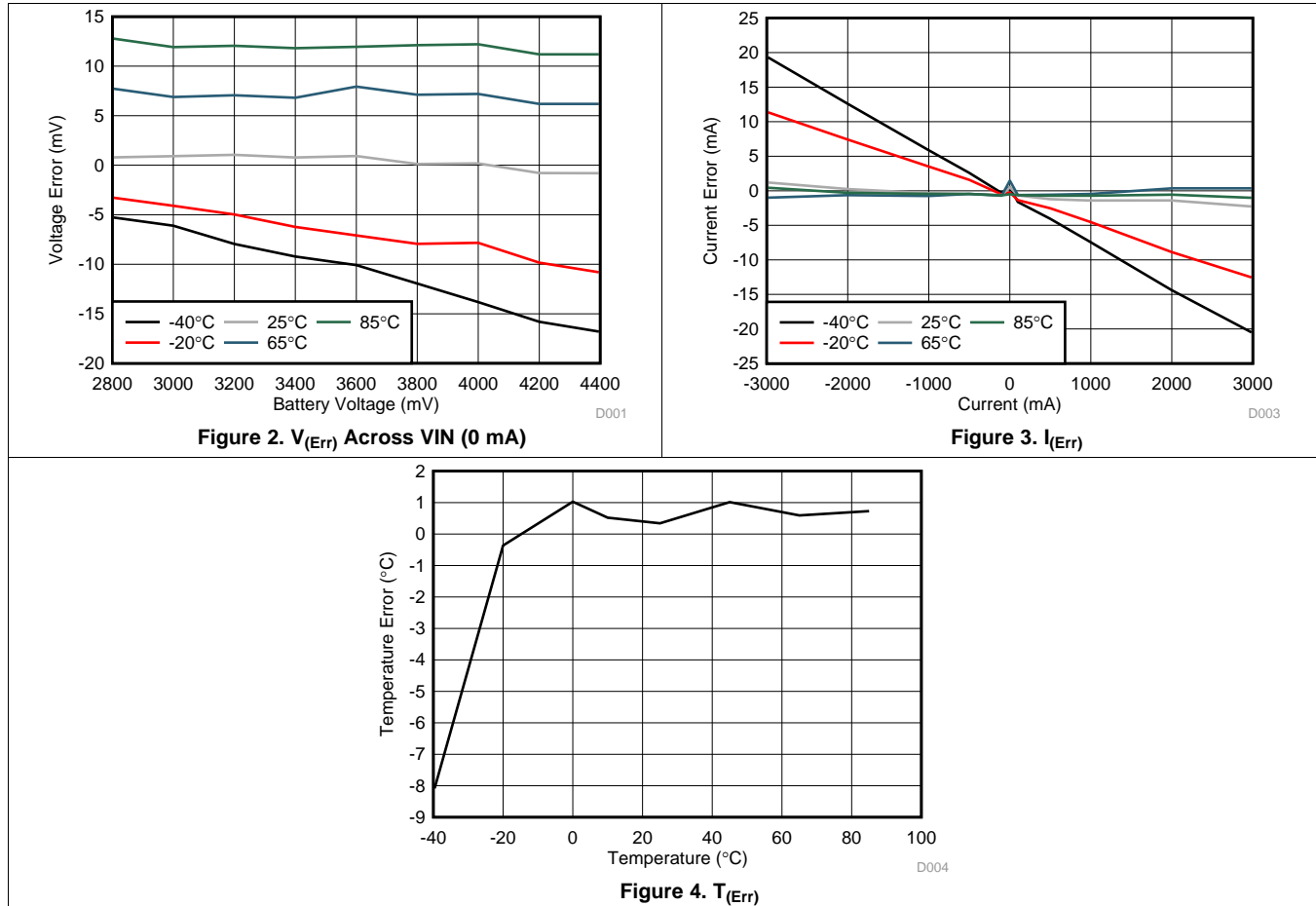

Figure 1. I²C-Compatible Interface Timing Diagrams

6.14 Typical Characteristics



7 Detailed Description

7.1 Overview

The bq35100 Battery Monitor provides gas gauging for Lithium Thionyl Chloride (LiSOCl₂) and Lithium Manganese Dioxide (LiMnO₂) primary batteries without requiring any forced discharge of the battery. The lithium primary gas gauging function uses voltage, current, and temperature data to provide State-Of-Health (SOH) and End-Of-Service (EOS) data.

7.2 Functional Block Diagram

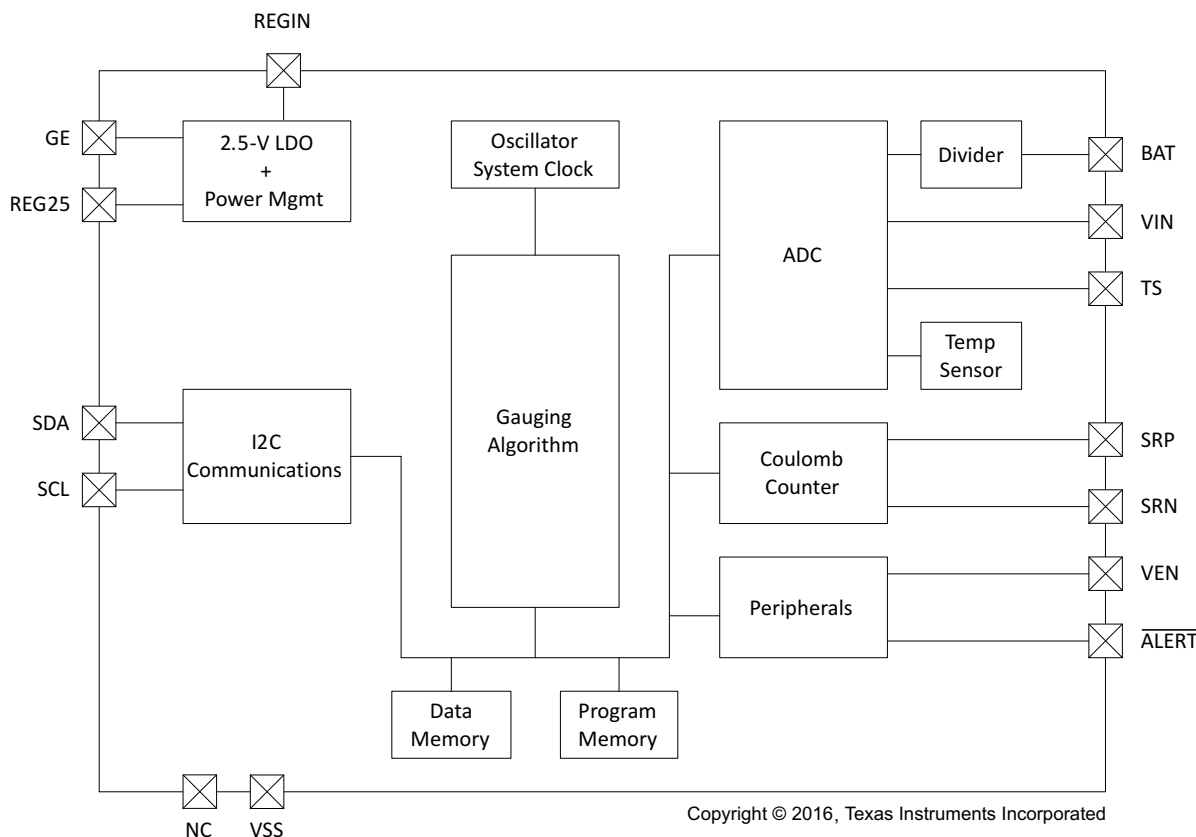

7.3 Feature Description

7.3.1 Basic Measurement Systems

7.3.1.1 Voltage

The device measures the BAT input, which is scaled by the internal translation network, through the ADC. The translation gain function is determined by a calibration process.

In systems where the battery voltage is greater than $V_{IN(BAT) MAX}$ (for example, 2-series cell or more), then an external voltage scaling circuit is required. The firmware then scales this <1 V value to reflect an average cell value and then again by the number of series cells to reflect the full battery voltage value.

7.3.1.2 Temperature

The device can measure temperature through an integrated temperature sensor or an external NTC thermistor. Only one source can be used and the selection is made by setting **Operation Config A [TEMPS]** appropriately. The resulting measured temperature is available through the *Temperature()* command. The internal temperature sensor result is also available through the *InternalTemperature()* command.

Feature Description (continued)

7.3.1.3 Coulombs

The integrating delta-sigma ADC in the device measures the discharge flow of the battery by measuring the voltage drop across a small-value sense resistor between the SRP and SRN pins.

The 15-bit integrating ADC measures bipolar signals from -0.125 V to 0.125 V. The device continuously monitors the measured current and integrates this value over time using an internal counter.

7.3.1.4 Current

For the primary battery current, the standard delta-sigma ADC in the device measures the discharge current of the battery by measuring the voltage drop across a small-value sense resistor between the SRP and SRN pins, and is available through the *Current()* command.

The measured current also includes the current consumed by the device. To subtract this value from the reported current, a value programmed in **EOS Gauge Load Current** is subtracted for improved accuracy.

7.3.2 Battery Gauging

The bq35100 can operate in three distinct modes: ACCUMULATOR (ACC) mode, STATE-OF-HEALTH (SOH) mode, and END-OF-SERVICE mode (EOS). The device can be configured and used for only one of these modes in the field, as it is not intended to be able to actively switch between modes when in normal use.

7.3.2.1 ACCUMULATOR Mode (ACC)

In this mode, the bq35100 measures and updates cell voltage, cell temperature, and load current every 1 s. This data is provided through the I²C interface while *ControlStatus()* [GA] is set.

7.3.2.2 STATE-OF-HEALTH (SOH) Mode

This mode is suitable for determining SOH for Lithium Manganese Dioxide (LiMnO₂) chemistry. In this mode, cell voltage and temperature are precisely measured immediately after the GE pin is asserted. The gauge uses this data to compute SOH.

7.3.2.2.1 Low State-of-Health Alert

BatteryStatus() [SOH_LOW] is set when *StateOfCharge()* is less than or equal to the value programmed in **SOHLOW**.

7.3.2.3 END-OF-SERVICE (EOS) Mode

This mode is suitable for gauging Lithium Thionyl Chloride (LiSOCl₂) cells. The End-Of-Service (EOS) gauging algorithm uses voltage, current, and temperature data to determine the resistance (R) and rate of change of resistance of the battery. The resistance data is then used to find Depth of Discharge (DOD) = DOD(R). As above, SOH is determined and in turn used to determine the EOS condition.

7.3.2.3.1 Initial EOS Learning

For optimal accuracy, the first event where the device updates its impedance value is required to be when the battery is full (a fresh battery). If the battery has been partially discharged, then the accuracy of the EOS detection will be compromised.

When a new battery is inserted, then the *NEW_BATTERY()* command should be sent to the device to ensure the initial learned resistance **RNEW** is refreshed correctly.

7.3.2.3.1.1 End-Of-Service Detection

The bq35100 can detect when a sharp increase in the trend of tracked impedance occurs, indicating that the battery is reaching its EOS condition.

Feature Description (continued)

7.3.3 Power Control

The bq35100 only has one active power mode that is enabled through the GAUGE ENABLE (GE) pin. The power consumption of the bq35100 can change significantly based on host commands that it receives and its default configuration, specifically with respect to data flash updates.

7.3.4 Battery Condition Warnings

7.3.4.1 Battery Low Warning

The bq35100 can indicate and optionally trigger the $\overline{\text{ALERT}}$ pin when the primary battery voltage falls below a programmable threshold.

7.3.4.2 Temperature Low Warning

The bq35100 can indicate and optionally trigger the $\overline{\text{ALERT}}$ pin when the primary battery temperature falls below a programmable threshold.

7.3.4.3 Temperature High Warning

The bq35100 can indicate and optionally trigger the $\overline{\text{ALERT}}$ pin when the primary battery temperature rises above a programmable threshold.

7.3.4.4 Battery Low SOH Warning

The bq35100 can indicate and optionally trigger the $\overline{\text{ALERT}}$ pin when the primary battery state-of-health (SOH) falls below a programmable threshold.

7.3.4.5 Battery EOS OCV BAD Warning

The device assumes that when GE is asserted the cell is at rest and uses the initialization voltage reading to determine the Open Circuit Voltage (OCV). If the cell was not fully relaxed at that point, then the voltage after the pulse could rise above the OCV. This causes an incorrect impedance to be calculated.

7.3.5 $\overline{\text{ALERT}}$ Signal

The $\overline{\text{ALERT}}$ signal can be configured to be triggered by a variety of status conditions. When the **ALERT Configuration** bit is set AND the corresponding bit in *BatteryStatus()* or *ControlStatus()* is set, then the corresponding *BatteryAlert()* bit is set, triggering the $\overline{\text{ALERT}}$ signal.

7.3.6 Lifetime Data Collection

The bq35100 can be enabled by writing to *Control()* 0x002E [*LT_EN*] to gather data regarding the primary battery and store it to data flash.

The following data is collected in RAM and only written to DF when the host sends the *End* command to the device:

- Max and Min Cell Voltage
- Max and Min Discharge Current
- Max and Min Temperature

7.3.7 SHA-1 Authentication

As of March 2012, the latest revision is FIPS 180-4. SHA-1, or secure hash algorithm, is used to compute a condensed representation of a message or data also known as hash. For messages $< 2^{64}$, the SHA-1 algorithm produces a 160-bit output called a digest.

In a SHA-1 one-way hash function, there is no known mathematical method of computing the input given, only the output. The specification of SHA-1, as defined by FIPS 180-4, states that the input consists of 512-bit blocks with a total input length less than 2^{64} bits. Inputs that do not conform to integer multiples of 512-bit blocks are padded before any block is input to the hash function. The SHA-1 algorithm outputs the 160-bit digest.

Feature Description (continued)

The device generates a SHA-1 input block of 288 bits (total input = 160-bit message + 128-bit key). To complete the 512-bit block size requirement of the SHA-1 function, the device pads the key and message with a 1, followed by 159 0s, followed by the 64 bit value for 288 (000...00100100000), which conforms to the pad requirements specified by FIPS 180-4.

- <http://www.nist.gov/itl/>
- <http://csrc.nist.gov/publications/fips>
- www.faqs.org/rfcs/rfc3174.html

7.3.8 Data Commands

7.3.8.1 Command Summary

Table 1. Command Summary Table

Cmd	Mode	Name	Format	Size in Bytes	Min Value	Max Value	Default Value	Unit
0x00...0x01	R/W	<i>Control</i>	Hex	2	0x00	0xff	—	—
0x02...0x05	R	<i>AccumulatedCapacity</i>	Integer	4	0	4.29e9	—	μAh
0x06...0x07	R	<i>Temperature</i>	Signed Int	2	-32768	32767	—	0.1°K
0x08...0x09	R	<i>Voltage</i>	Integer	2	0	65535	—	mV
0x0A	R	<i>BatteryStatus</i>	Hex	1	0x00	0xff	—	—
0x0B	R	<i>BatteryAlert</i>	Hex	1	0x00	0xff	—	—
0x0C...0x0D	R	<i>Current</i>	Signed Integer	2	-32768	32767	—	mA
0x16...0x17	R	<i>Scaled R</i>	Integer	2	0	65535	—	mΩ
0x22...0x23	R	<i>Measured Z</i>	Integer	2	0	65535	—	mΩ
0x28...0x29	R	<i>InternalTemperature</i>	Signed Integer	2	-32768	32767	—	0.1°K
0x2E...0x2F	R	<i>StateOfHealth</i>	Integer	1	0	100	—	%
0x3C...0x3D	R	<i>DesignCapacity</i>	Integer	2	0	65535	—	mAh
0x79	R	<i>Cal_Count</i>	Hex	1	0x00	0xff	—	—
0x7a...0x7B	R	<i>Cal_Current</i>	Signed Int	2	0	65535	—	mA
0x7C...0x7D	R	<i>Cal_Voltage</i>	Integer	2	0	65535	—	mV or Counts ⁽¹⁾
0x7E...0x7F	R	<i>Cal_Temperature</i>	Integer	2	0	65535	—	°K

(1) mV when [EXTVCELL] = 0 and ADC counts when [EXTVCELL] = 1

7.3.8.2 0x00, 0x01 *AltManufacturerAccess()* and 0x3E, 0x3F *AltManufacturerAccess()*

AltManufacturerAccess() provides a method of reading and writing data in the Manufacturer Access System (MAC). The MAC command is sent via *AltManufacturerAccess()* by a block protocol. The result is returned on *AltManufacturerAccess()* via a block read.

Commands are set by writing to registers 0x00/0x01. On valid word access, the MAC command state is set, and commands 0x3E and 0x3F are used for MAC commands. These new addresses work the same as 0x00 and 0x01, but are primarily intended for block writes and reads.

7.3.8.3 *Control()*: 0x00/0x01

Issuing a *Control()* command requires a subsequent two-byte subcommand. These additional bytes specify the particular control function desired. The *Control()* command allows the host to control specific features of the device during normal operation, and additional features when the bq35100 is in different access modes, as described in [Table 2](#).

Table 2. Control Functions

CNTL FUNCTION	CNTL DATA	SEALED ACCESS	DESCRIPTION
CONTROL_STATUS	0x0000	Yes	Reports the status of key features
DEVICE_TYPE	0x0001	Yes	Reports the device type of 0x40 (indicating bq35100)
FW_VERSION	0x0002	Yes	Reports the firmware version on the device type
HW_VERSION	0x0003	Yes	Reports the hardware version of the device type
STATIC_CHEM_CHKSUM	0x0005	Yes	Calculates chemistry checksum
CHEM_ID	0x0006	Yes	Reports the chemical identifier used by the gas gauge algorithms
PREV_MACWRITE	0x0007	Yes	Returns previous <i>Control()</i> command code
BOARD_OFFSET	0x0009	Yes	Forces the device to measure and store the board offset
CC_OFFSET	0x000A	Yes	Forces the device to measure the internal CC offset
CC_OFFSET_SAVE	0x000B	Yes	Forces the device to store the internal CC offset
DF_VERSION	0x000C	Yes	Reports the data flash version on the device
GAUGE_START	0x0011	Yes	Triggers the device to enter active mode
GAUGE_STOP	0x0012	Yes	Triggers the device to stop gauging and complete all outstanding tasks
SELAED	0x0020	No	Places the device in SEALED access mode
CAL_ENABLE	0x002D	No	Toggle CALIBRATION mode enable
LT_ENABLE	0x002E	No	Enables Lifetime Data collection
RESET	0x0041	No	Forces a full reset of the device
EXIT_CAL	0x0080	No	Exit CALIBRATION mode
ENTER_CAL	0x0081	No	Enter CALIBRATION mode
NEW_BATTERY	0xa613	Yes	This is used to refresh the gauge when a new battery is installed and resets all recorded data.

7.3.9 Communications

7.3.9.1 I²C Interface

The gas gauge supports the standard I²C read, incremental read, one-byte write quick read, and functions. The 7-bit device address (ADDR) is the most significant 7 bits of the hex address and is fixed as 1010101. The 8-bit device address is therefore 0xAA or 0xAB for write or read, respectively.

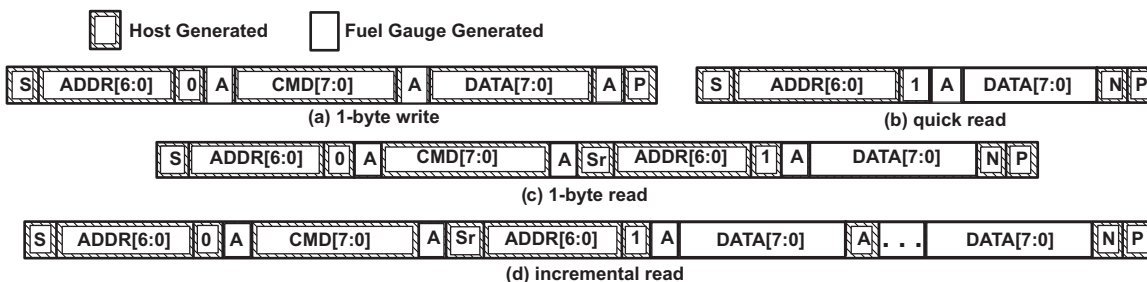

Figure 5. Supported I²C Formats: (a) 1-Byte Write, (b) Quick Read, (c) 1 Byte-read, and (d) Incremental Read (S = Start, Sr = Repeated Start, A = Acknowledge, N = No Acknowledge, and P = Stop).

The “quick read” returns data at the address indicated by the address pointer. The address pointer, a register internal to the I²C communication engine, increments whenever data is acknowledged by the device or the I²C master. “Quick writes” function in the same manner and are a convenient means of sending multiple bytes to consecutive command locations (such as 2-byte commands that require two bytes of data).



Figure 6. Attempt To Write a Read-Only Address (Nack After Data Sent By Master)



Figure 7. Attempt To Read an Address Above 0x7F (Nack Command)



Figure 8. Attempt at Incremental Writes (Nack All Extra Data Bytes Sent)

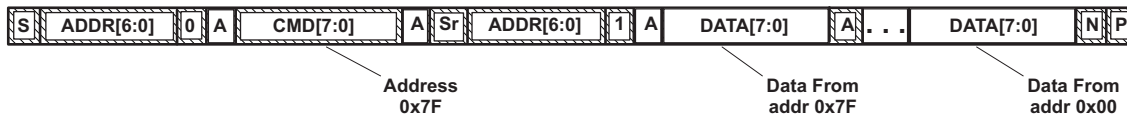

Figure 9. Incremental Read at the Maximum Allowed Read Address

The I²C engine releases both SDA and SCL if the I²C bus is held low for **Bus Low Time**. If the gas gauge was holding the lines, releasing them frees the master to drive the lines. If an external condition is holding either of the lines low, the I²C engine enters the low-power SLEEP mode.

7.4 Device Functional Modes

The bq35100 is intended for systems where the battery electronics are required to consume a very low average current. To achieve this, the device is intended to be fully powered off when not required through control of the GAUGE ENABLE (GE) pin. When this pin is low, then the device is fully powered down with no measurements being made and no data, unless in flash, is retained.

An example system current profile is shown along with the state of GAUGE ENABLE to reduce the average power consumption of the battery electronics.

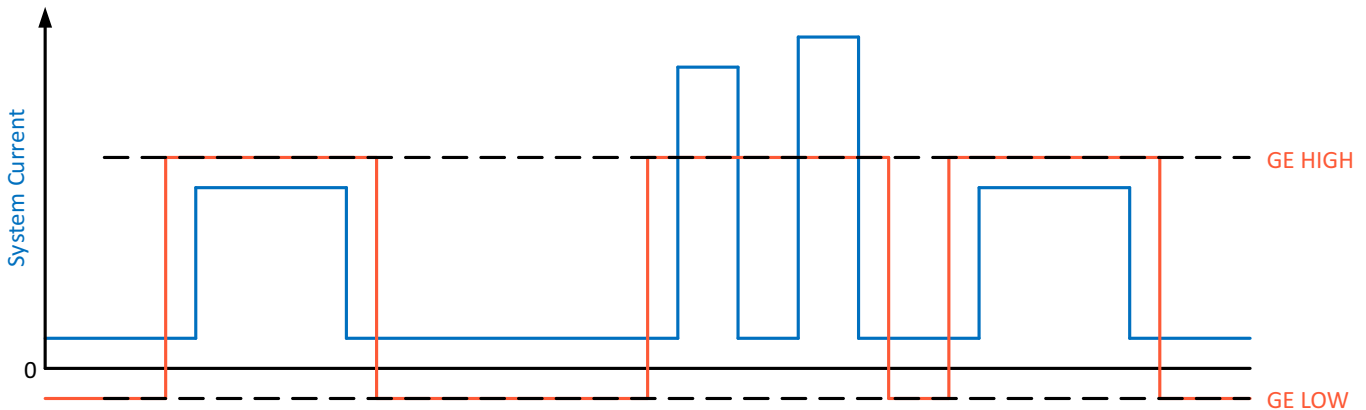

Figure 10. Power Consumption

The average power consumption of the bq35100 is an average of the periods where GAUGE ENABLE is high AND low over a given period.

For example, if the system enters a high power state (500 μ A) for 30 s every 4 hours, the average current will be:
 $500 \mu\text{A} \times 30 \text{ s} / 4 \text{ h} = 1.042 \mu\text{A}$

The flowchart below highlights the operational flow and conditional decisions.

Device Functional Modes (continued)

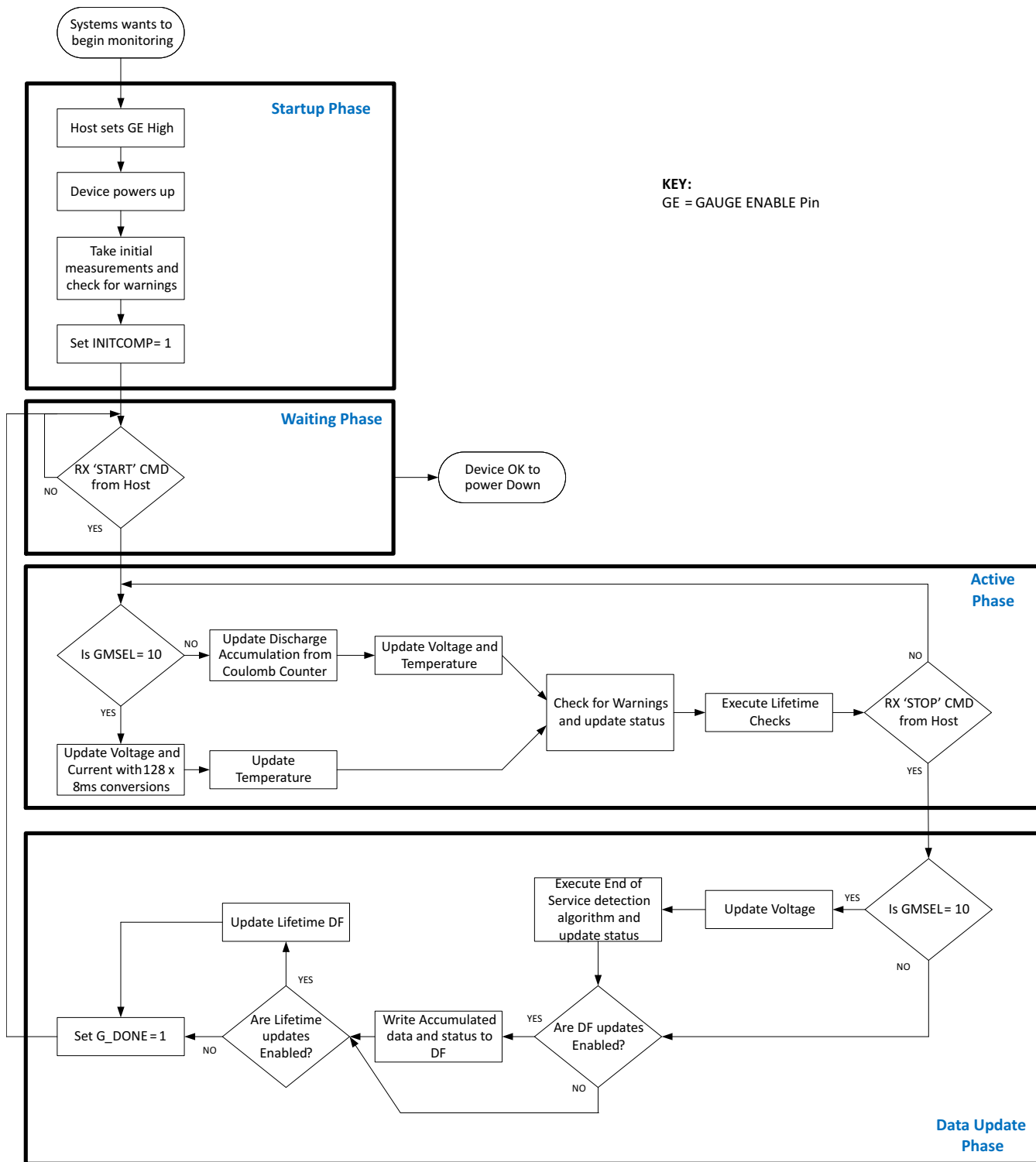

Figure 11. Operational Flow

8 Application and Implementation

NOTE

Information in the following applications sections is not part of the TI component specification, and TI does not warrant its accuracy or completeness. TI's customers are responsible for determining suitability of components for their purposes. Customers should validate and test their design implementation to confirm system functionality.

8.1 Application Information

The bq35100 is a highly configurable device with many options. The major configuration choices comprise the battery chemistry and energy buffer choices.

8.2 Typical Applications

Figure 12 is a simplified diagram of the main features of the bq35100. Specific implementations detailing the main configuration options are shown later in this section.

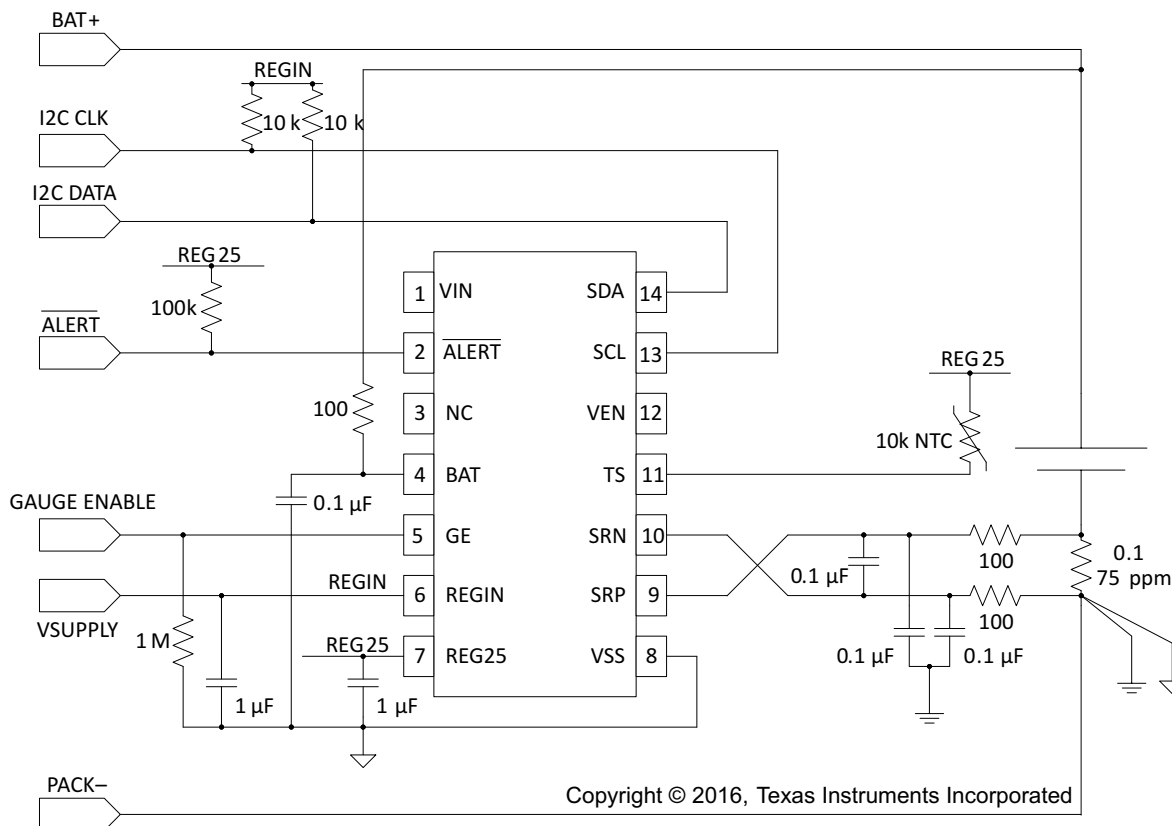

Figure 12. bq35100 Single-Cell Simplified Implementation

Typical Applications (continued)

8.2.1 Design Requirements

For design guidelines, refer to the *bq35100 EVM User's Guide* ([SLUUBH7](#)).

8.2.2 Detailed Design Procedure

8.2.2.1 Gauging Mode Selection

The bq35100 can be used in any one of three different modes with the selection of the mode based on the battery chemistry. The selection is made with the **GMSEL[1:0]** bits in **Operation Config A**.

The voltage correlation mode is typically used with Lithium Manganese Dioxide (LiMnO₂) cells as the voltage vs. state-of-health (SOH) profile has a defined slope to enable accuracy. The resistance correlation mode is only used with Lithium Thionyl Chloride (LiSOCl₂) cells.

The ACCUMULATOR mode (ACC) is chemistry-independent, but also provides no gas gauging data, such as Remaining State-Of-Health, Full Charge Capacity, or End-Of-Service (EOS) indication. This is the default configuration as it is also the required mode for the device when it is calibrated. Once calibration is completed, the device can be set to the appropriate gauging mode.

8.2.2.2 Voltage Measurement Selection

The default configuration is for the bq35100 to support 1-series cell with a maximum of 4.5 V. If the battery voltage can be above this level, then **[EXTVCELL]** in **Operation Config A** should be set. In this setting, an external resistor divider is used to scale the voltage so the gauge can measure accurately.

8.2.2.3 Temperature Measurement Selection

There are three options for temperature measurement in the bq35100. By default, the device is configured to use an external 103AT NTC thermistor. However, if **[TEMPS]** = 0, then an internal temperature sensor is used. This requires no external components but for optimal performance in this case, the bq35100 should be very close to the cell, preferably thermally connected.

There is one other option that can be used if the system already includes a cell temperature measurement solution: If **WRTEMP** = 1, then the host can write the temperature to the device and the bq35100 algorithms will use that data.

8.2.2.4 Current Sense Resistor Selection

The bq35100 calculates current through measuring a voltage across a small resistor in series with the battery. The default value is 100 mΩ. To maximize current measurement accuracy, the ideal value is calculated as:

$$R_{\text{SENSE}} \text{ (m}\Omega\text{)} = V_{\text{(SR)MAX}} / \text{Peak Load Current (mA)}$$

Where $V_{\text{(SR)MAX}} = 125 \text{ mV}$

8.2.3 Expected Device Usage Profiles

The bq35100 is designed to work in a system where there is a period discharge pulse of at least 10 s of mA for 10 s of ms. In ACC mode, any pulse can be measured based on the information the host requires. However, in EOS modes, the battery condition does not change very fast so only pulses that are many hours apart; for example, 24 hours, are needed.

If the time between pulses needing monitoring is less than a minute, then it is recommended not to power down the device. However, if the period is greater than 5 hours, then powering down the device between pulses is expected. Periods in between risk not allowing the battery to rest and any EOS-related data may be compromised. [Battery EOS OCV BAD Warning](#) provides more information on this.

The shorter the period between pulses has a large effect of the overall cumulative power consumption of the battery electronics. See [Device Functional Modes](#) for more details on average power consumption.

Typical Applications (continued)

8.2.4 Application Curves

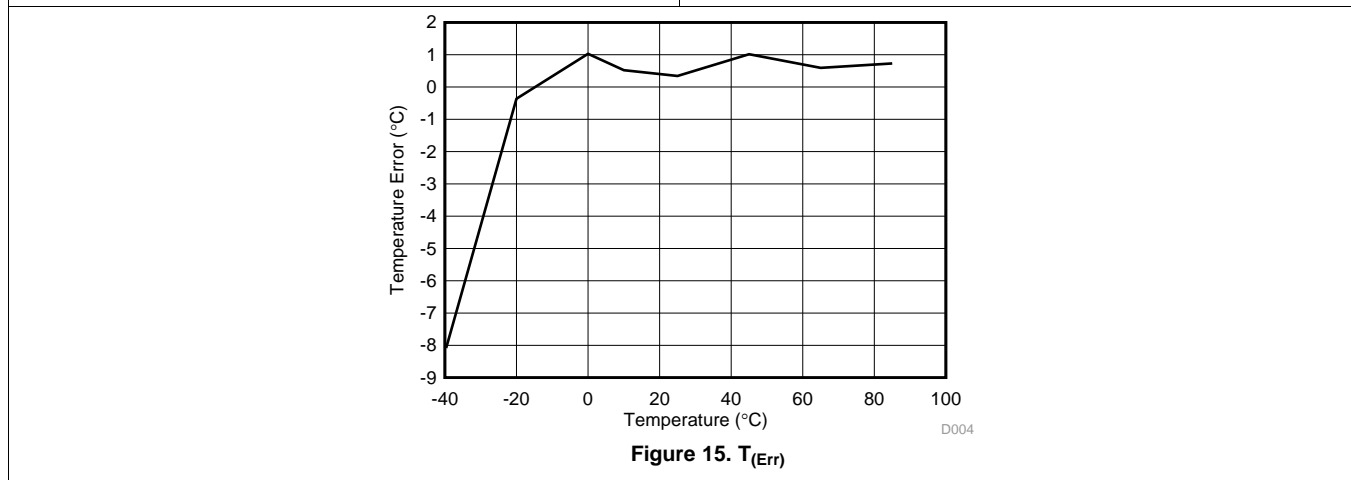
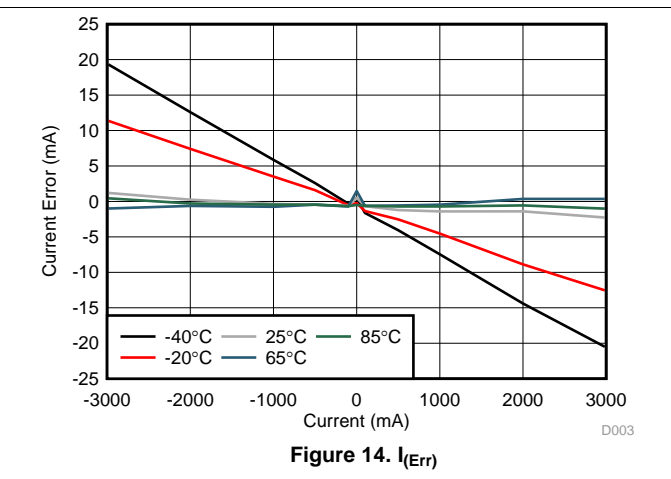
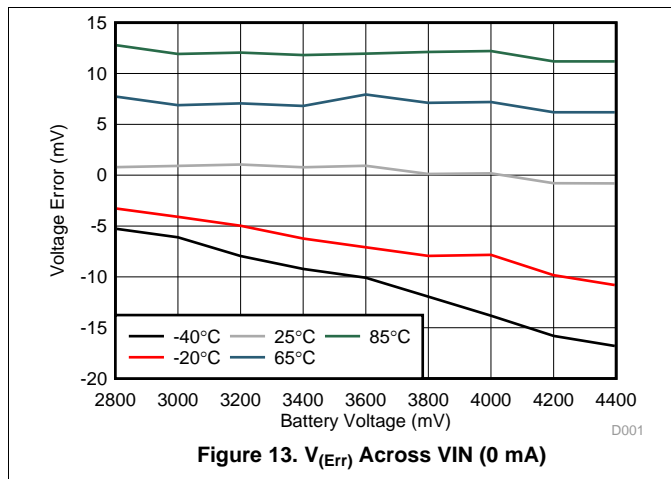

9 Power Supply Recommendations

Power supply requirements for the bq35100 are simplified due to the presence of the internal LDO voltage regulation. The REGIN pin accepts any voltage level between 2.7 V and 4.5 V, which is optimum for single-cell Li-primary applications.

Decoupling the REGIN pin should be done with a 0.1- μ F 10% ceramic X5R capacitor placed close to the device.

REGIN can be powered from an alternate power source, such as, for example, the boost converter output, as long as it is not also connected to the BAT input. In this case, BAT should only remain connected to the top of the cell.

10 Layout

10.1 Layout Guidelines

10.1.1 Introduction

Attention to layout is critical to the success of any battery management circuit board. The mixture of high-current paths with an ultralow-current microcontroller creates the potential for design issues that are not always trivial to solve. Some of the key areas of concern are described in the following sections, and can help to enable success.

Layout Guidelines (continued)

10.1.2 Power Supply Decoupling Capacitor

Power supply decoupling from V_{REG25} to ground is important for optimal operation of the gas gauge. To keep the loop area small, place this capacitor next to the IC and use the shortest possible traces. A large loop area renders the capacitor useless and forms a small-loop antenna for noise pickup. Ideally, the traces on each side of the capacitor should be the same length and run in the same direction to avoid differential noise during ESD. If possible, place a via near the V_{SS} pin to a ground plane layer.

10.1.3 Capacitors

Power supply decoupling for the gas gauge requires a pair of 0.1- μF ceramic capacitors for (PBAT) and (V_{REG25}) pins. These should be placed reasonably close to the IC without using long traces back to V_{SS} . The LDO voltage regulator, whether external or internal to the main IC, requires a 0.47- μF ceramic capacitor to be placed fairly close to the regulation output pin. This capacitor is for amplifier loop stabilization and as an energy well for the 2.5-V supply.

10.1.4 Communication Line Protection Components

The 5.6-V Zener diodes used to protect the communication pins of the gas gauge from ESD should be located as close as possible to the pack connector. The grounded end of these Zener diodes should be returned to the Pack(-) node rather than to the low-current digital ground system. This way, ESD is diverted away from the sensitive electronics as much as possible.

10.2 Layout Example

10.2.1 Ground System

The fuel gauge requires a low-current ground system separate from the high-current PACK(-) path. ESD ground is defined along the high-current path from the Pack(-) terminal to the sense resistor. It is important that the low-current ground systems only connect to the PACK(-) path at the sense resistor Kelvin pick-off point. It is recommended to use an optional inner layer ground plane for the low-current ground system.

In [Figure 16](#), the green is an example of using the low-current ground as a shield for the gas gauge circuit. Notice how it is kept separate from the high-current ground, which is shown in red. The high-current path is joined with the low-current path only at one point, shown with the small blue connection between the two planes.

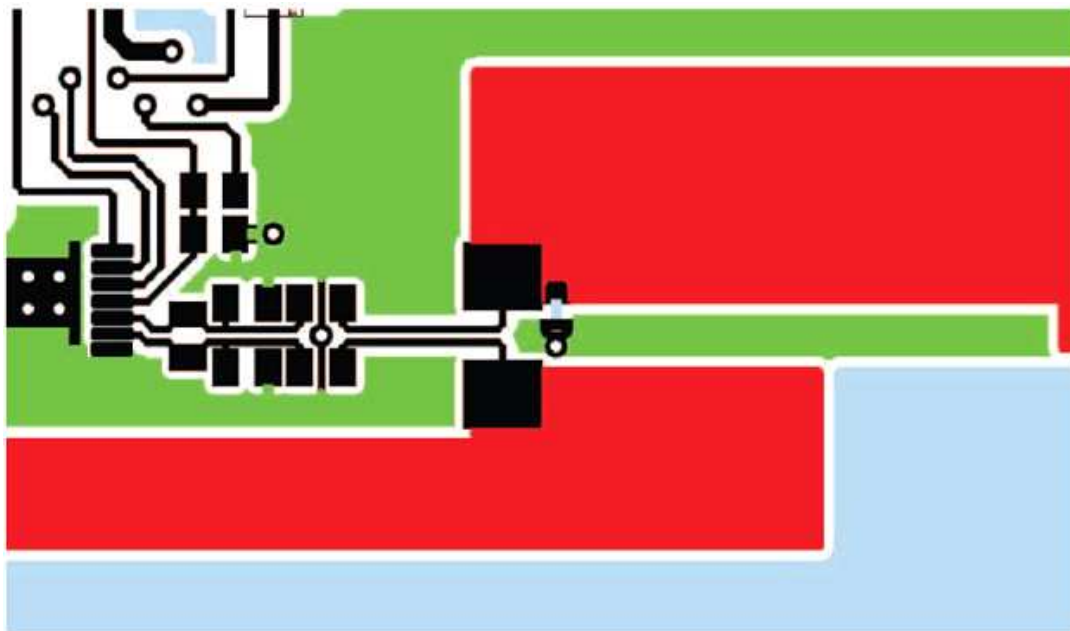

Figure 16. Differential Filter Component with Symmetrical Layout

Layout Example (continued)

10.2.2 Kelvin Connections

Kelvin voltage sensing is very important to accurately measure current and cell voltage. Note how the differential connections at the sense resistor do not add any voltage drop across the copper etch that carries the high current path through the sense resistor. See [Figure 16](#) and [Figure 17](#).

10.2.3 Board Offset Considerations

Although the most important component for board offset reduction is the decoupling capacitor for V_{REG25} , additional benefit is possible by using this recommended pattern for the coulomb counter differential low-pass filter network. Maintain the symmetrical placement pattern shown for optimum current offset performance. Use symmetrical shielded differential traces, if possible, from the sense resistor to the 100- Ω resistors, as shown in [Figure 17](#).

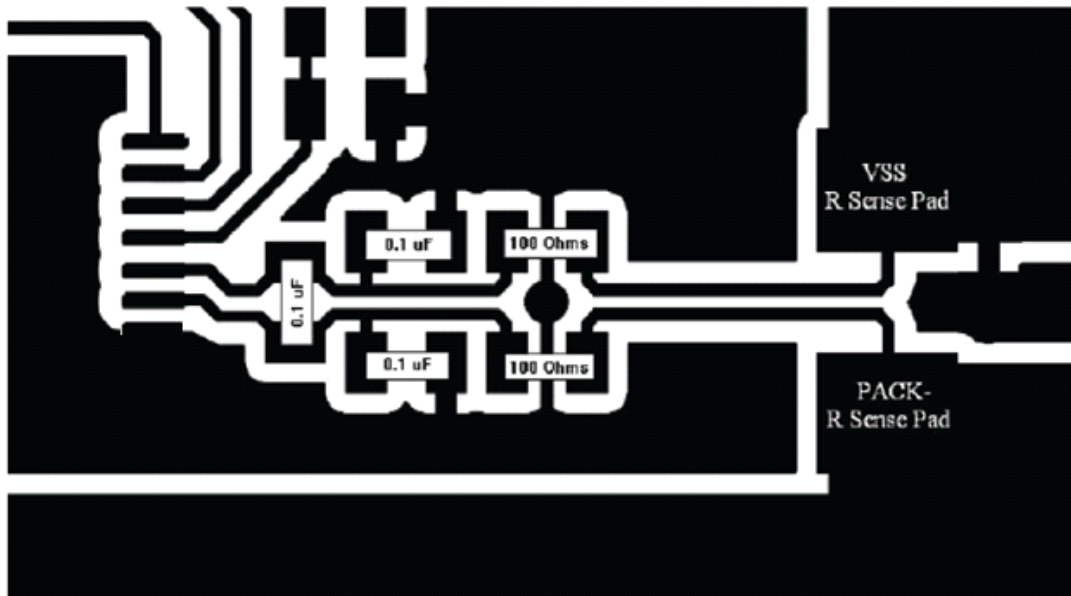

Figure 17. Differential Connection Between SRP and SRN Pins with Sense Resistor

10.3 ESD Spark Gap

Protect the communication lines from ESD with a spark gap at the connector. [Figure 18](#) shows the recommended pattern with its 0.2-mm spacing between the points.

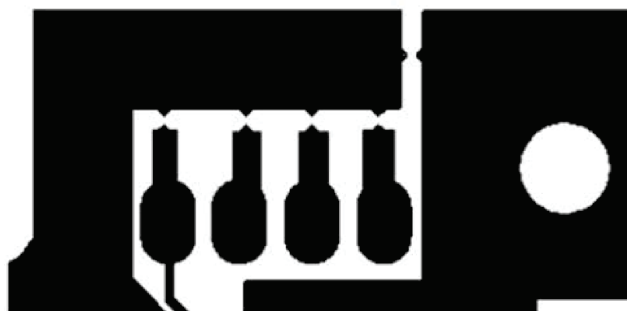

Figure 18. Recommended Spark-Gap Pattern Helps Protect Communication Lines from ESD

11 Device and Documentation Support

11.1 Documentation Support

11.1.1 Related Documentation

For related documentation, see the following:

- *bq35100 Technical Reference Manual* ([SLUUBH1](#))
- *bq35100 EVM User's Guide* ([SLUUBH7](#))
- *Using I²C Communication with the bq275xx Series of Fuel Gauges Application Report* ([SLUA467](#))

11.2 Receiving Notification of Documentation Updates

To receive notification of documentation updates, navigate to the device product folder on ti.com. In the upper right corner, click on *Alert me* to register and receive a weekly digest of any product information that has changed. For change details, review the revision history included in any revised document.

11.3 Community Resources

The following links connect to TI community resources. Linked contents are provided "AS IS" by the respective contributors. They do not constitute TI specifications and do not necessarily reflect TI's views; see TI's [Terms of Use](#).

TI E2E™ Online Community *TI's Engineer-to-Engineer (E2E) Community*. Created to foster collaboration among engineers. At [e2e.ti.com](#), you can ask questions, share knowledge, explore ideas and help solve problems with fellow engineers.

Design Support *TI's Design Support* Quickly find helpful E2E forums along with design support tools and contact information for technical support.

11.4 Trademarks

E2E is a trademark of Texas Instruments.

I²C is a trademark of NXP B.V. Corporation.

All other trademarks are the property of their respective owners.

11.5 Electrostatic Discharge Caution



This integrated circuit can be damaged by ESD. Texas Instruments recommends that all integrated circuits be handled with appropriate precautions. Failure to observe proper handling and installation procedures can cause damage.

ESD damage can range from subtle performance degradation to complete device failure. Precision integrated circuits may be more susceptible to damage because very small parametric changes could cause the device not to meet its published specifications.

11.6 Glossary

[SLYZ022](#) — *TI Glossary*.

This glossary lists and explains terms, acronyms, and definitions.

12 Mechanical, Packaging, and Orderable Information

The following pages include mechanical, packaging, and orderable information. This information is the most current data available for the designated devices. This data is subject to change without notice and revision of this document. For browser-based versions of this data sheet, refer to the left-hand navigation.

PACKAGING INFORMATION

Orderable Device	Status (1)	Package Type	Package Drawing	Pins	Package Qty	Eco Plan (2)	Lead/Ball Finish (6)	MSL Peak Temp (3)	Op Temp (°C)	Device Marking (4/5)	Samples
BQ35100PW	ACTIVE	TSSOP	PW	14	90	Green (RoHS & no Sb/Br)	CU NIPDAU	Level-2-260C-1 YEAR	-40 to 85	BQ35100	Samples
BQ35100PWR	ACTIVE	TSSOP	PW	14	2000	Green (RoHS & no Sb/Br)	CU NIPDAU	Level-2-260C-1 YEAR	-40 to 85	BQ35100	Samples

(1) The marketing status values are defined as follows:

ACTIVE: Product device recommended for new designs.

LIFEBUY: TI has announced that the device will be discontinued, and a lifetime-buy period is in effect.

NRND: Not recommended for new designs. Device is in production to support existing customers, but TI does not recommend using this part in a new design.

PREVIEW: Device has been announced but is not in production. Samples may or may not be available.

OBSELETE: TI has discontinued the production of the device.

(2) Eco Plan - The planned eco-friendly classification: Pb-Free (RoHS), Pb-Free (RoHS Exempt), or Green (RoHS & no Sb/Br) - please check <http://www.ti.com/productcontent> for the latest availability information and additional product content details.

TBD: The Pb-Free/Green conversion plan has not been defined.

Pb-Free (RoHS): TI's terms "Lead-Free" or "Pb-Free" mean semiconductor products that are compatible with the current RoHS requirements for all 6 substances, including the requirement that lead not exceed 0.1% by weight in homogeneous materials. Where designed to be soldered at high temperatures, TI Pb-Free products are suitable for use in specified lead-free processes.

Pb-Free (RoHS Exempt): This component has a RoHS exemption for either 1) lead-based flip-chip solder bumps used between the die and package, or 2) lead-based die adhesive used between the die and leadframe. The component is otherwise considered Pb-Free (RoHS compatible) as defined above.

Green (RoHS & no Sb/Br): TI defines "Green" to mean Pb-Free (RoHS compatible), and free of Bromine (Br) and Antimony (Sb) based flame retardants (Br or Sb do not exceed 0.1% by weight in homogeneous material)

(3) MSL, Peak Temp. - The Moisture Sensitivity Level rating according to the JEDEC industry standard classifications, and peak solder temperature.

(4) There may be additional marking, which relates to the logo, the lot trace code information, or the environmental category on the device.

(5) Multiple Device Markings will be inside parentheses. Only one Device Marking contained in parentheses and separated by a "~" will appear on a device. If a line is indented then it is a continuation of the previous line and the two combined represent the entire Device Marking for that device.

(6) Lead/Ball Finish - Orderable Devices may have multiple material finish options. Finish options are separated by a vertical ruled line. Lead/Ball Finish values may wrap to two lines if the finish value exceeds the maximum column width.

Important Information and Disclaimer: The information provided on this page represents TI's knowledge and belief as of the date that it is provided. TI bases its knowledge and belief on information provided by third parties, and makes no representation or warranty as to the accuracy of such information. Efforts are underway to better integrate information from third parties. TI has taken and continues to take reasonable steps to provide representative and accurate information but may not have conducted destructive testing or chemical analysis on incoming materials and chemicals. TI and TI suppliers consider certain information to be proprietary, and thus CAS numbers and other limited information may not be available for release.

In no event shall TI's liability arising out of such information exceed the total purchase price of the TI part(s) at issue in this document sold by TI to Customer on an annual basis.

TAPE AND REEL INFORMATION



QUADRANT ASSIGNMENTS FOR PIN 1 ORIENTATION IN TAPE



*All dimensions are nominal

Device	Package Type	Package Drawing	Pins	SPQ	Reel Diameter (mm)	Reel Width W1 (mm)	A0 (mm)	B0 (mm)	K0 (mm)	P1 (mm)	W (mm)	Pin1 Quadrant
BQ35100PWR	TSSOP	PW	14	2000	330.0	12.4	6.9	5.6	1.6	8.0	12.0	Q1

TAPE AND REEL BOX DIMENSIONS



*All dimensions are nominal

Device	Package Type	Package Drawing	Pins	SPQ	Length (mm)	Width (mm)	Height (mm)
BQ35100PWR	TSSOP	PW	14	2000	338.1	338.1	20.6

PW (R-PDSO-G14)

PLASTIC SMALL OUTLINE



4040064-3/G 02/11

- NOTES:
- A. All linear dimensions are in millimeters. Dimensioning and tolerancing per ASME Y14.5M-1994.
 - B. This drawing is subject to change without notice.
 - C. Body length does not include mold flash, protrusions, or gate burrs. Mold flash, protrusions, or gate burrs shall not exceed 0,15 each side.
 - D. Body width does not include interlead flash. Interlead flash shall not exceed 0,25 each side.
 - E. Falls within JEDEC MO-153

PW (R-PDSO-G14)

PLASTIC SMALL OUTLINE



- NOTES:
- All linear dimensions are in millimeters.
 - This drawing is subject to change without notice.
 - Publication IPC-7351 is recommended for alternate designs.
 - Laser cutting apertures with trapezoidal walls and also rounding corners will offer better paste release. Customers should contact their board assembly site for stencil design recommendations. Refer to IPC-7525 for other stencil recommendations.
 - Customers should contact their board fabrication site for solder mask tolerances between and around signal pads.

IMPORTANT NOTICE

Texas Instruments Incorporated and its subsidiaries (TI) reserve the right to make corrections, enhancements, improvements and other changes to its semiconductor products and services per JESD46, latest issue, and to discontinue any product or service per JESD48, latest issue. Buyers should obtain the latest relevant information before placing orders and should verify that such information is current and complete. All semiconductor products (also referred to herein as "components") are sold subject to TI's terms and conditions of sale supplied at the time of order acknowledgment.

TI warrants performance of its components to the specifications applicable at the time of sale, in accordance with the warranty in TI's terms and conditions of sale of semiconductor products. Testing and other quality control techniques are used to the extent TI deems necessary to support this warranty. Except where mandated by applicable law, testing of all parameters of each component is not necessarily performed.

TI assumes no liability for applications assistance or the design of Buyers' products. Buyers are responsible for their products and applications using TI components. To minimize the risks associated with Buyers' products and applications, Buyers should provide adequate design and operating safeguards.

TI does not warrant or represent that any license, either express or implied, is granted under any patent right, copyright, mask work right, or other intellectual property right relating to any combination, machine, or process in which TI components or services are used. Information published by TI regarding third-party products or services does not constitute a license to use such products or services or a warranty or endorsement thereof. Use of such information may require a license from a third party under the patents or other intellectual property of the third party, or a license from TI under the patents or other intellectual property of TI.

Reproduction of significant portions of TI information in TI data books or data sheets is permissible only if reproduction is without alteration and is accompanied by all associated warranties, conditions, limitations, and notices. TI is not responsible or liable for such altered documentation. Information of third parties may be subject to additional restrictions.

Resale of TI components or services with statements different from or beyond the parameters stated by TI for that component or service voids all express and any implied warranties for the associated TI component or service and is an unfair and deceptive business practice. TI is not responsible or liable for any such statements.

Buyer acknowledges and agrees that it is solely responsible for compliance with all legal, regulatory and safety-related requirements concerning its products, and any use of TI components in its applications, notwithstanding any applications-related information or support that may be provided by TI. Buyer represents and agrees that it has all the necessary expertise to create and implement safeguards which anticipate dangerous consequences of failures, monitor failures and their consequences, lessen the likelihood of failures that might cause harm and take appropriate remedial actions. Buyer will fully indemnify TI and its representatives against any damages arising out of the use of any TI components in safety-critical applications.

In some cases, TI components may be promoted specifically to facilitate safety-related applications. With such components, TI's goal is to help enable customers to design and create their own end-product solutions that meet applicable functional safety standards and requirements. Nonetheless, such components are subject to these terms.

No TI components are authorized for use in FDA Class III (or similar life-critical medical equipment) unless authorized officers of the parties have executed a special agreement specifically governing such use.

Only those TI components which TI has specifically designated as military grade or "enhanced plastic" are designed and intended for use in military/aerospace applications or environments. Buyer acknowledges and agrees that any military or aerospace use of TI components which have **not** been so designated is solely at the Buyer's risk, and that Buyer is solely responsible for compliance with all legal and regulatory requirements in connection with such use.

TI has specifically designated certain components as meeting ISO/TS16949 requirements, mainly for automotive use. In any case of use of non-designated products, TI will not be responsible for any failure to meet ISO/TS16949.

Products

Audio	www.ti.com/audio
Amplifiers	amplifier.ti.com
Data Converters	dataconverter.ti.com
DLP® Products	www.dlp.com
DSP	dsp.ti.com
Clocks and Timers	www.ti.com/clocks
Interface	interface.ti.com
Logic	logic.ti.com
Power Mgmt	power.ti.com
Microcontrollers	microcontroller.ti.com
RFID	www.ti-rfid.com
OMAP Applications Processors	www.ti.com/omap
Wireless Connectivity	www.ti.com/wirelessconnectivity

Applications

Automotive and Transportation	www.ti.com/automotive
Communications and Telecom	www.ti.com/communications
Computers and Peripherals	www.ti.com/computers
Consumer Electronics	www.ti.com/consumer-apps
Energy and Lighting	www.ti.com/energy
Industrial	www.ti.com/industrial
Medical	www.ti.com/medical
Security	www.ti.com/security
Space, Avionics and Defense	www.ti.com/space-avionics-defense
Video and Imaging	www.ti.com/video

TI E2E Community

e2e.ti.com